

FDB8874

N-Channel PowerTrench® MOSFET 30V, 121A, 4.7mΩ

General Description

This N-Channel MOSFET has been designed specifically to improve the overall efficiency of DC/DC converters using either synchronous or conventional switching PWM controllers. It has been optimized for low gate charge, low $r_{DS(ON)}$ and fast switching speed.

Features

- $r_{DS(ON)} = 4.7m\Omega$, $V_{GS} = 10V$, $I_D = 40A$
- $r_{DS(ON)} = 6.0m\Omega$, $V_{GS} = 4.5V$, $I_D = 40A$
- High performance trench technology for extremely low $r_{DS(ON)}$
- Low gate charge
- High power and current handling capability
- RoHS Compliant

Applications

- DC/DC converters

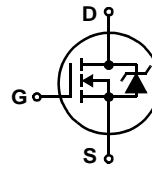
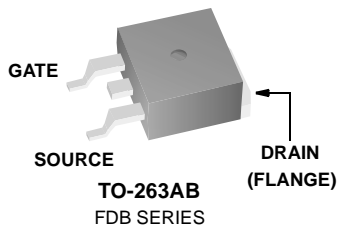

MOSFET Maximum Ratings $T_C = 25^\circ C$ unless otherwise noted

| Symbol | Parameter | Ratings | Units |
|----------------|--|------------|---------------|
| V_{DSS} | Drain to Source Voltage | 30 | V |
| V_{GS} | Gate to Source Voltage | ± 20 | V |
| I_D | Drain Current | | |
| | Continuous ($T_C = 25^\circ C$, $V_{GS} = 10V$) (Note 1) | 121 | A |
| | Continuous ($T_C = 25^\circ C$, $V_{GS} = 4.5V$) (Note 1) | 107 | A |
| | Continuous ($T_{amb} = 25^\circ C$, $V_{GS} = 10V$, with $R_{\theta JA} = 43^\circ C/W$) | 21 | A |
| | Pulsed | Figure 4 | A |
| E_{AS} | Single Pulse Avalanche Energy (Note 2) | 105 | mJ |
| P_D | Power dissipation | 110 | W |
| | Derate above $25^\circ C$ | 0.73 | W/ $^\circ C$ |
| T_J, T_{STG} | Operating and Storage Temperature | -55 to 175 | $^\circ C$ |

Thermal Characteristics

| | | | |
|-----------------|---|------|--------------|
| $R_{\theta JC}$ | Thermal Resistance Junction to Case TO-263 | 1.36 | $^\circ C/W$ |
| $R_{\theta JA}$ | Thermal Resistance Junction to Ambient TO-263 (Note 3) | 62 | $^\circ C/W$ |
| $R_{\theta JA}$ | Thermal Resistance Junction to Ambient TO-263, 1in ² copper pad area | 43 | $^\circ C/W$ |

Package Marking and Ordering Information

| Device Marking | Device | Package | Reel Size | Tape Width | Quantity |
|----------------|---------|----------|-----------|------------|-----------|
| FDB8874 | FDB8874 | TO-263AB | 330mm | 24mm | 800 units |

Electrical Characteristics $T_C = 25^\circ\text{C}$ unless otherwise noted

| Symbol | Parameter | Test Conditions | Min | Typ | Max | Units |
|--------|-----------|-----------------|-----|-----|-----|-------|
|--------|-----------|-----------------|-----|-----|-----|-------|

Off Characteristics

| | | | | | | |
|------------|-----------------------------------|--|----|---|-----------|---------------|
| B_{VDSS} | Drain to Source Breakdown Voltage | $I_D = 250\mu\text{A}, V_{GS} = 0\text{V}$ | 30 | - | - | V |
| I_{DSS} | Zero Gate Voltage Drain Current | $V_{DS} = 24\text{V}$ $V_{GS} = 0\text{V}$ $T_C = 150^\circ\text{C}$ | - | - | 1 | μA |
| I_{GSS} | Gate to Source Leakage Current | $V_{GS} = \pm 20\text{V}$ | - | - | ± 100 | nA |

On Characteristics

| | | | | | | |
|--------------|----------------------------------|---|-----|--------|--------|----------|
| $V_{GS(TH)}$ | Gate to Source Threshold Voltage | $V_{GS} = V_{DS}, I_D = 250\mu\text{A}$ | 1.2 | - | 2.5 | V |
| $r_{DS(ON)}$ | Drain to Source On Resistance | $I_D = 40\text{A}, V_{GS} = 10\text{V}$ | - | 0.0033 | 0.0047 | Ω |
| | | $I_D = 40\text{A}, V_{GS} = 4.5\text{V}$ | - | 0.0041 | 0.0060 | |
| | | $I_D = 40\text{A}, V_{GS} = 10\text{V},$ $T_J = 175^\circ\text{C}$ | - | 0.0062 | 0.0080 | |

Dynamic Characteristics

| | | | | | | | |
|--------------|----------------------------------|---|---|------|-----|----------|----|
| C_{ISS} | Input Capacitance | $V_{DS} = 15\text{V}, V_{GS} = 0\text{V},$ $f = 1\text{MHz}$ | - | 3130 | - | pF | |
| C_{OSS} | Output Capacitance | | - | 590 | - | pF | |
| C_{RSS} | Reverse Transfer Capacitance | | - | 345 | - | pF | |
| R_G | Gate Resistance | $V_{GS} = 0.5\text{V}, f = 1\text{MHz}$ | - | 1.9 | - | Ω | |
| $Q_{g(TOT)}$ | Total Gate Charge at 10V | $V_{GS} = 0\text{V to } 10\text{V}$ | $V_{DD} = 15\text{V}$ $I_D = 40\text{A}$ $I_g = 1.0\text{mA}$ | - | 56 | 72 | nC |
| $Q_{g(5)}$ | Total Gate Charge at 5V | $V_{GS} = 0\text{V to } 5\text{V}$ | | - | 30 | 38 | nC |
| $Q_{g(TH)}$ | Threshold Gate Charge | $V_{GS} = 0\text{V to } 1\text{V}$ | | - | 3.0 | 4.0 | nC |
| Q_{gs} | Gate to Source Gate Charge | | | - | 9.0 | - | nC |
| Q_{gs2} | Gate Charge Threshold to Plateau | | | - | 6.0 | - | nC |
| Q_{gd} | Gate to Drain "Miller" Charge | | | - | 11 | - | nC |

Switching Characteristics ($V_{GS} = 10\text{V}$)

| | | | | | | |
|--------------|---------------------|--|---|-----|-----|----|
| t_{ON} | Turn-On Time | $V_{DD} = 15\text{V}, I_D = 40\text{A}$ $V_{GS} = 10\text{V}, R_{GS} = 4.7\Omega$ | - | - | 217 | ns |
| $t_{d(ON)}$ | Turn-On Delay Time | | - | 10 | - | ns |
| t_r | Rise Time | | - | 135 | - | ns |
| $t_{d(OFF)}$ | Turn-Off Delay Time | | - | 45 | - | ns |
| t_f | Fall Time | | - | 34 | - | ns |
| t_{OFF} | Turn-Off Time | | - | - | 118 | ns |

Drain-Source Diode Characteristics

| | | | | | | |
|----------|-------------------------------|---|---|---|------|----|
| V_{SD} | Source to Drain Diode Voltage | $I_{SD} = 40\text{A}$ | - | - | 1.25 | V |
| | | $I_{SD} = 20\text{A}$ | - | - | 1.0 | V |
| t_{rr} | Reverse Recovery Time | $I_{SD} = 40\text{A}, dl_{SD}/dt = 100\text{A}/\mu\text{s}$ | - | - | 32 | ns |
| Q_{RR} | Reverse Recovered Charge | $I_{SD} = 40\text{A}, dl_{SD}/dt = 100\text{A}/\mu\text{s}$ | - | - | 18 | nC |

Notes:

- Package current limitation is 80A.
- Starting $T_J = 25^\circ\text{C}$, $L = 51\mu\text{H}$, $I_{AS} = 64\text{A}$, $V_{DD} = 27\text{V}$, $V_{GS} = 10\text{V}$.
- Pulse width = 100s.

Typical Characteristics $T_C = 25^\circ\text{C}$ unless otherwise noted

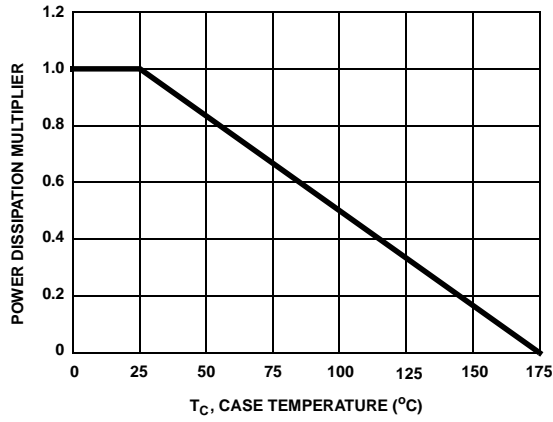

Figure 1. Normalized Power Dissipation vs Case Temperature

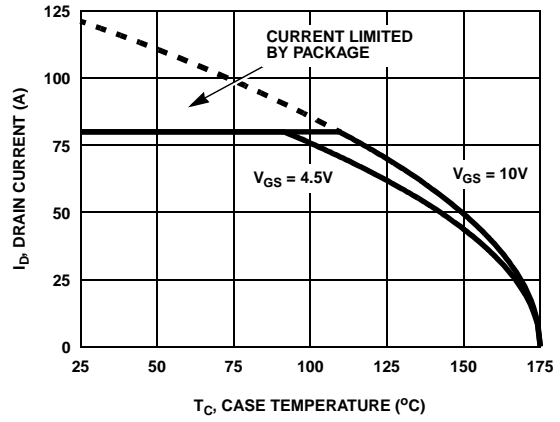

Figure 2. Maximum Continuous Drain Current vs Case Temperature

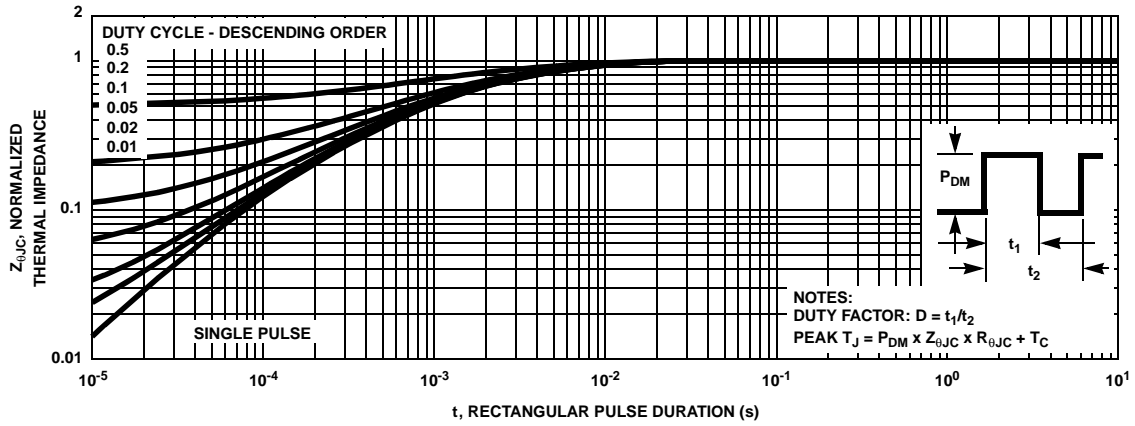

Figure 3. Normalized Maximum Transient Thermal Impedance

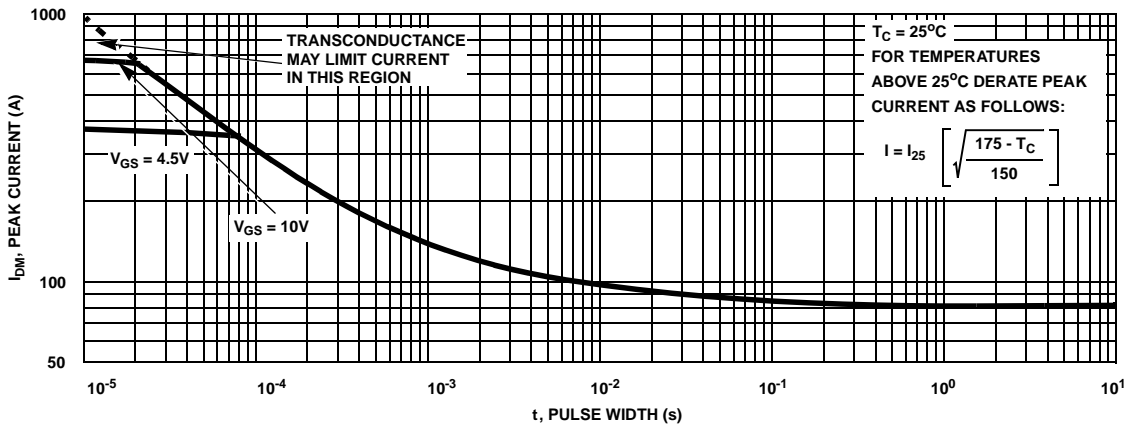

Figure 4. Peak Current Capability

Typical Characteristics $T_C = 25^\circ\text{C}$ unless otherwise noted

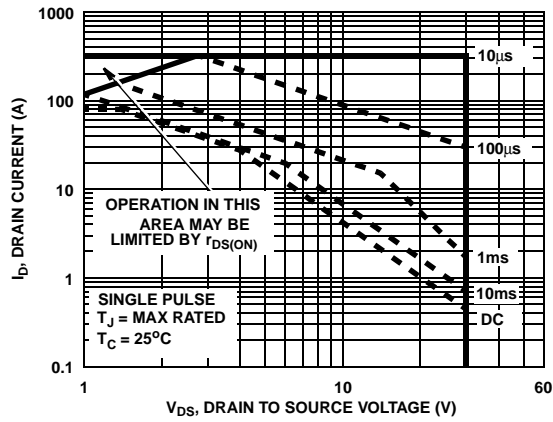

Figure 5. Forward Bias Safe Operating Area

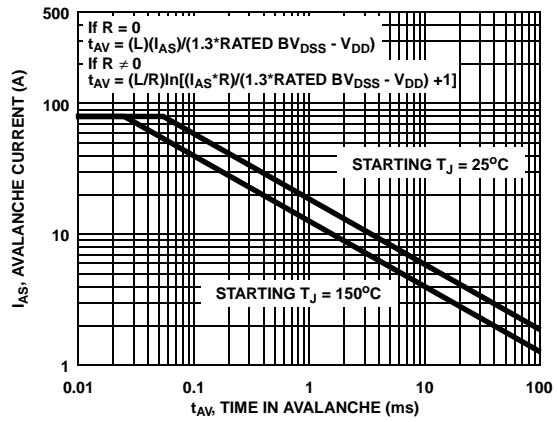

Figure 6. Unclamped Inductive Switching Capability
 NOTE: Refer to Fairchild Application Notes AN7514 and AN7515

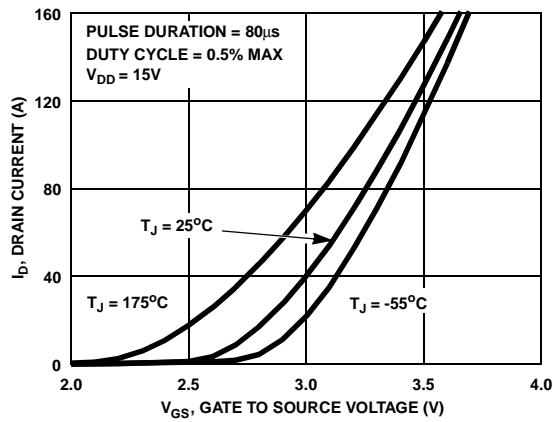

Figure 7. Transfer Characteristics

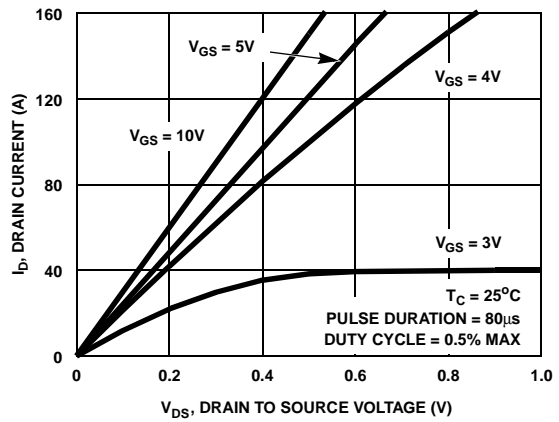

Figure 8. Saturation Characteristics

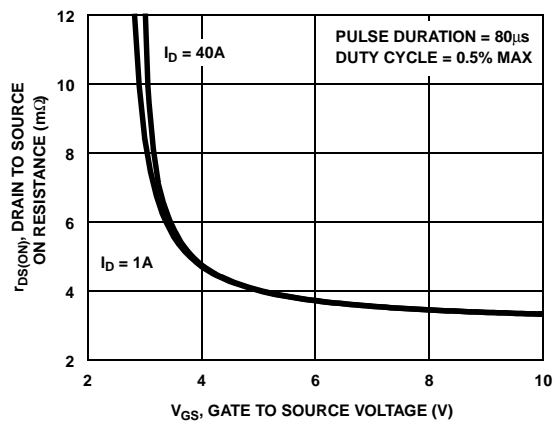

Figure 9. Drain to Source On Resistance vs Gate Voltage and Drain Current

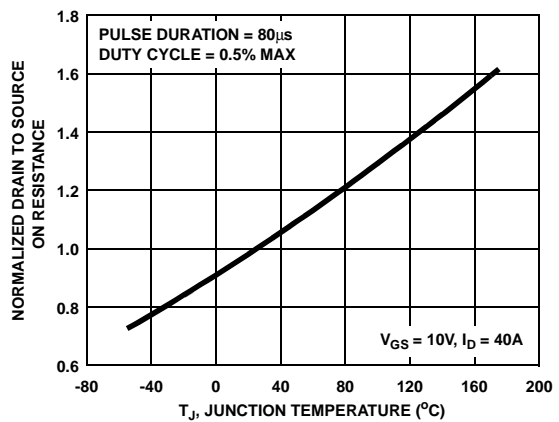

Figure 10. Normalized Drain to Source On Resistance vs Junction Temperature

Typical Characteristics $T_C = 25^\circ\text{C}$ unless otherwise noted

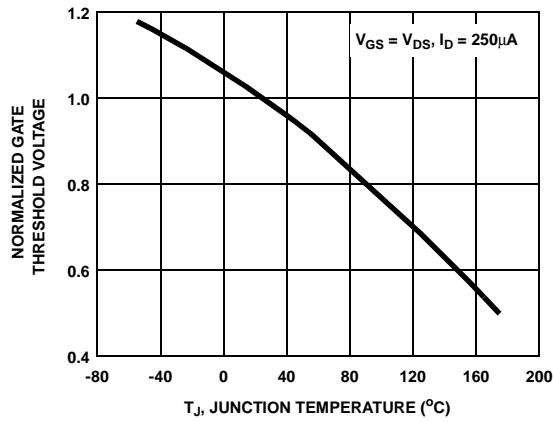

Figure 11. Normalized Gate Threshold Voltage vs Junction Temperature

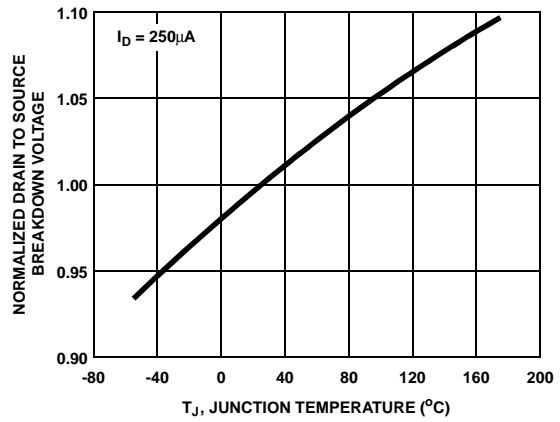

Figure 12. Normalized Drain to Source Breakdown Voltage vs Junction Temperature

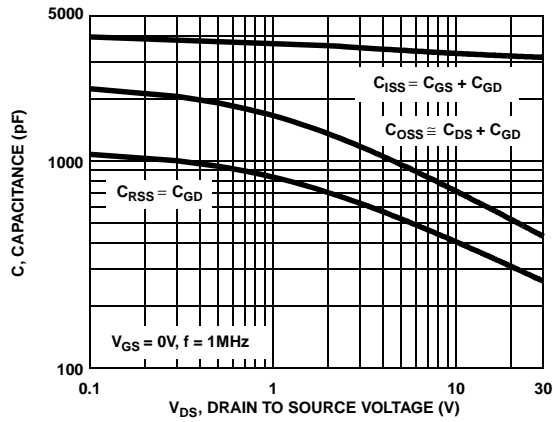

Figure 13. Capacitance vs Drain to Source Voltage

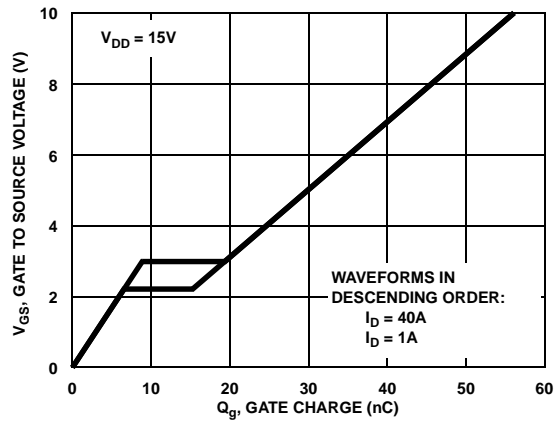

Figure 14. Gate Charge Waveforms for Constant Gate Current

Test Circuits and Waveforms



Figure 15. Unclamped Energy Test Circuit



Figure 16. Unclamped Energy Waveforms



Figure 17. Gate Charge Test Circuit



Figure 18. Gate Charge Waveforms



Figure 19. Switching Time Test Circuit

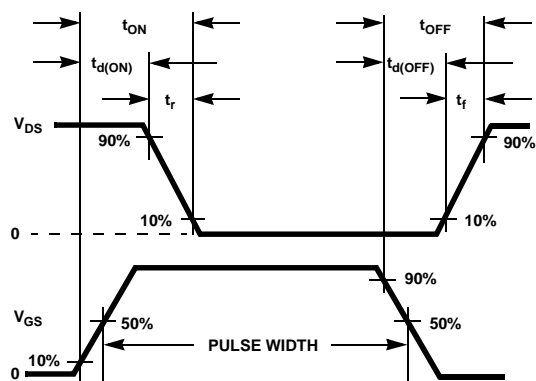

Figure 20. Switching Time Waveforms

Thermal Resistance vs. Mounting Pad Area

The maximum rated junction temperature, T_{JM} , and the thermal resistance of the heat dissipating path determines the maximum allowable device power dissipation, P_{DM} , in an application. Therefore the application's ambient temperature, T_A ($^{\circ}C$), and thermal resistance $R_{\theta JA}$ ($^{\circ}C/W$) must be reviewed to ensure that T_{JM} is never exceeded. Equation 1 mathematically represents the relationship and serves as the basis for establishing the rating of the part.

$$P_{DM} = \frac{(T_{JM} - T_A)}{R_{\theta JA}} \quad (EQ. 1)$$

In using surface mount devices such as the TO-263 package, the environment in which it is applied will have a significant influence on the part's current and maximum power dissipation ratings. Precise determination of P_{DM} is complex and influenced by many factors:

1. Mounting pad area onto which the device is attached and whether there is copper on one side or both sides of the board.
2. The number of copper layers and the thickness of the board.
3. The use of external heat sinks.
4. The use of thermal vias.
5. Air flow and board orientation.
6. For non steady state applications, the pulse width, the duty cycle and the transient thermal response of the part, the board and the environment they are in.

Fairchild provides thermal information to assist the designer's preliminary application evaluation. Figure 21 defines the $R_{\theta JA}$ for the device as a function of the top copper (component side) area. This is for a horizontally positioned FR-4 board with 1oz copper after 1000 seconds of steady state power with no air flow. This graph provides the necessary information for calculation of the steady state junction temperature or power dissipation. Pulse applications can be evaluated using the Fairchild device Spice thermal model or manually utilizing the normalized maximum transient thermal impedance curve.

Thermal resistances corresponding to other copper areas can be obtained from Figure 21 or by calculation using Equation 2 or 3. Equation 2 is used for copper area defined in inches square and equation 3 is for area in centimeters square. The area, in square inches or square centimeters is the top copper area including the gate and source pads.

$$R_{\theta JA} = 26.51 + \frac{19.84}{(0.262 + Area)} \quad (EQ. 2)$$

Area in Inches Squared

$$R_{\theta JA} = 26.51 + \frac{128}{(1.69 + Area)} \quad (EQ. 3)$$

Area in Centimeters Squared

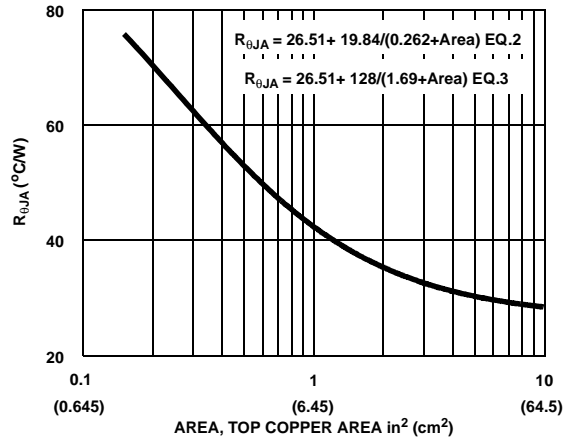

Figure 21. Thermal Resistance vs Mounting Pad Area

PSPICE Electrical Model

.SUBCKT FDB8874 2 1 3 ; rev May 2004
 Ca 12 8 2.3e-9
 Cb 15 14 2.25e-9
 Cin 6 8 2.9e-9

Dbody 7 5 DbodyMOD
 Dbreak 5 11 DbreakMOD
 Dplcap 10 5 DplcapMOD

Ebreak 11 7 17 18 33.3
 Eds 14 8 5 8 1
 Egs 13 8 6 8 1
 Esg 6 10 6 8 1
 Evthres 6 21 19 8 1
 Evtemp 20 6 18 22 1

It 8 17 1

Lgate 1 9 8.5e-9
 Ldrain 2 5 1.0e-9
 Lsource 3 7 2.7e-9

RLgate 1 9 85
 RLdrain 2 5 10
 RLsource 3 7 27

Mmed 16 6 8 8 MmedMOD
 Mstro 16 6 8 8 MstroMOD
 Mweak 16 21 8 8 MweakMOD

Rbreak 17 18 RbreakMOD 1
 Rdrain 50 16 RdrainMOD 1.3e-3
 Rgate 9 20 1.9
 RSLC1 5 51 RSLCMOD 1e-6
 RSLC2 5 50 1e3
 Rsource 8 7 RsourceMOD 1.7e-3
 Rvthres 22 8 RvthresMOD 1
 Rvtemp 18 19 RvtempMOD 1
 S1a 6 12 13 8 S1AMOD
 S1b 13 12 13 8 S1BMOD
 S2a 6 15 14 13 S2AMOD
 S2b 13 15 14 13 S2BMOD

Vbat 22 19 DC 1

ESLC 51 50 VALUE={{(V(5,51)/ABS(V(5,51)))*(PWR(V(5,51))/(1e-6*500),10)}}

.MODEL DbodyMOD D (IS=4.1E-12 IKF=10 N=1.01 RS=2e-3 TRS1=8e-4 TRS2=2e-7
 + CJO=1.22e-9 M=0.57 TT=3e-12 XTl=3)

.MODEL DbreakMOD D (RS=8e-2 TRS1=1e-3 TRS2=-8.9e-6)

.MODEL DplcapMOD D (CJO=1.12e-9 IS=1e-30 N=10 M=0.42)

.MODEL MmedMOD NMOS (VTO=2 KP=9 IS=1e-30 N=10 TOX=1 L=1u W=1u RG=1.9)

.MODEL MstroMOD NMOS (VTO=2.5 KP=390 IS=1e-30 N=10 TOX=1 L=1u W=1u)

.MODEL MweakMOD NMOS (VTO=1.72 KP=0.05 IS=1e-30 N=10 TOX=1 L=1u W=1u RG=19 RS=0.1)

.MODEL RbreakMOD RES (TC1=8.3e-4 TC2=-8e-7)

.MODEL RdrainMOD RES (TC1=7.5e-3 TC2=6e-6)

.MODEL RSLCMOD RES (TC1=1e-4 TC2=1e-6)

.MODEL RsourceMOD RES (TC1=1e-4 TC2=2.5e-6)

.MODEL RvthresMOD RES (TC1=-2.4e-3 TC2=-8e-6)

.MODEL RvtempMOD RES (TC1=-1.8e-3 TC2=2e-7)

.MODEL S1AMOD VSWITCH (RON=1e-5 ROFF=0.1 VON=-4 VOFF=-3)

.MODEL S1BMOD VSWITCH (RON=1e-5 ROFF=0.1 VON=-3 VOFF=-4)

.MODEL S2AMOD VSWITCH (RON=1e-5 ROFF=0.1 VON=-2 VOFF=-0.5)

.MODEL S2BMOD VSWITCH (RON=1e-5 ROFF=0.1 VON=-0.5 VOFF=-2)

.ENDS

Note: For further discussion of the PSPICE model, consult **A New PSPICE Sub-Circuit for the Power MOSFET Featuring Global Temperature Options**; IEEE Power Electronics Specialist Conference Records, 1991, written by William J. Hepp and C. Frank Wheatley.

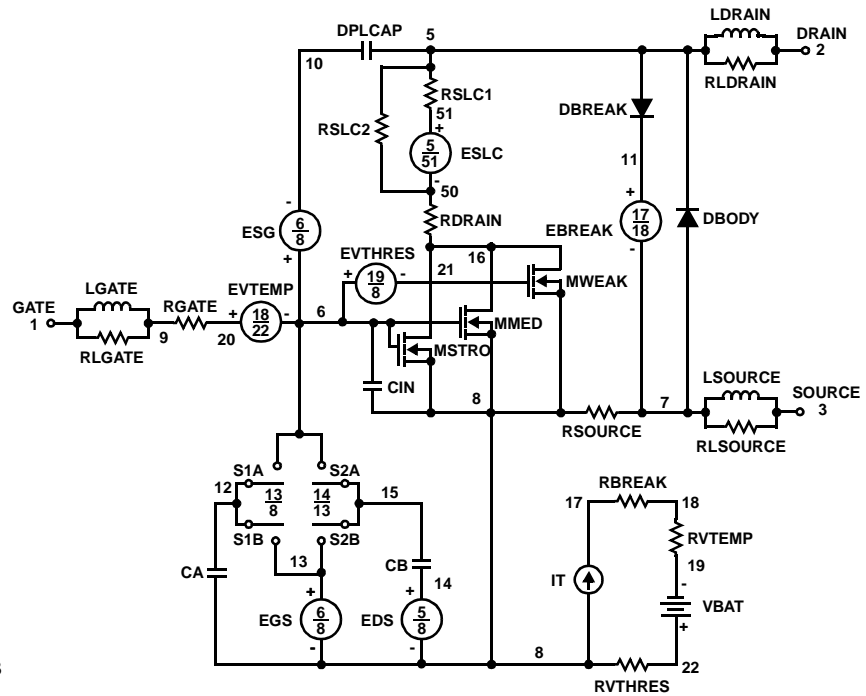

SABER Electrical Model

rev May 2004
 template FDB8874 n2,n1,n3
 electrical n2,n1,n3

```
{
var i iscl
dp..model dbodymod = (isl=4.1e-12,ikf=10,nl=1.01,rs=2e-3,trs1=8e-4,trs2=2e-7,cjo=1.22e-9,m=0.57,tt=3e-12,xti=3)
dp..model dbreakmod = (rs=8e-2,trs1=1e-3,trs2=-8.9e-6)
dp..model dplcapmod = (cjo=1.12e-9,isl=10e-30,nl=10,m=0.42)
m..model mmedmod = (type=_n,vto=2,kp=9,is=1e-30,tox=1)
m..model mstrongmod = (type=_n,vto=2.5,kp=390,is=1e-30,tox=1)
m..model mweakmod = (type=_n,vto=1.72,kp=0.05,is=1e-30,tox=1,rs=0.1)
sw_vcsp..model s1amod = (ron=1e-5,roff=0.1,von=-4,voff=-3)
sw_vcsp..model s1bmod = (ron=1e-5,roff=0.1,von=-3,voff=-4)
sw_vcsp..model s2amod = (ron=1e-5,roff=0.1,von=-2,voff=-0.5)
sw_vcsp..model s2bmod = (ron=1e-5,roff=0.1,von=-0.5,voff=-2)
c.ca n12 n8 = 2.3e-9
c.cb n15 n14 = 2.25e-9
c.cin n6 n8 = 2.9e-9
```

```
dp.dbody n7 n5 = model=dbodymod
dp.dbreak n5 n11 = model=dbreakmod
dp.dplcap n10 n5 = model=dplcapmod
```

```
spe.ebreak n11 n7 n17 n18 = 33.3
spe.eds n14 n8 n5 n8 = 1
spe.egs n13 n8 n6 n8 = 1
spe.esg n6 n10 n6 n8 = 1
spe.evthres n6 n21 n19 n8 = 1
spe.evtemp n20 n6 n18 n22 = 1
```

```
i.it n8 n17 = 1
```

```
l.lgate n1 n9 = 8.5e-9
l.ldrain n2 n5 = 1.0e-9
l.lsource n3 n7 = 2.7e-9
```

```
res.rlgate n1 n9 = 85
res.rldrain n2 n5 = 10
res.rlsource n3 n7 = 27
```

```
m.mmed n16 n6 n8 n8 = model=mmedmod, l=1u, w=1u
m.mstrong n16 n6 n8 n8 = model=mstrongmod, l=1u, w=1u
m.mweak n16 n21 n8 n8 = model=mweakmod, l=1u, w=1u
```

```
res.rbreak n17 n18 = 1, tc1=8.3e-4,tc2=-8e-7
res.rdrain n5 n16 = 1.3e-3, tc1=7.5e-3,tc2=6e-6
res.rgate n9 n20 = 1.9
res.rslc1 n5 n51 = 1e-6, tc1=1e-4,tc2=1e-6
res.rslc2 n5 n50 = 1e3
res.rsource n8 n7 = 1.7e-3, tc1=1e-4,tc2=2.5e-6
res.rvthres n22 n8 = 1, tc1=-2.4e-3,tc2=-8e-6
res.rvtemp n18 n19 = 1, tc1=-1.8e-3,tc2=2e-7
sw_vcsp.s1a n6 n12 n13 n8 = model=s1amod
sw_vcsp.s1b n13 n12 n13 n8 = model=s1bmod
sw_vcsp.s2a n6 n15 n14 n13 = model=s2amod
sw_vcsp.s2b n13 n15 n14 n13 = model=s2bmod
```

```
v.vbat n22 n19 = dc=1
```

```
equations {
i (n51->n50) +=iscl
iscl: v(n51,n50) = ((v(n5,n51)/(1e-9+abs(v(n5,n51))))*((abs(v(n5,n51))*1e6/500)** 10))
}
}
```

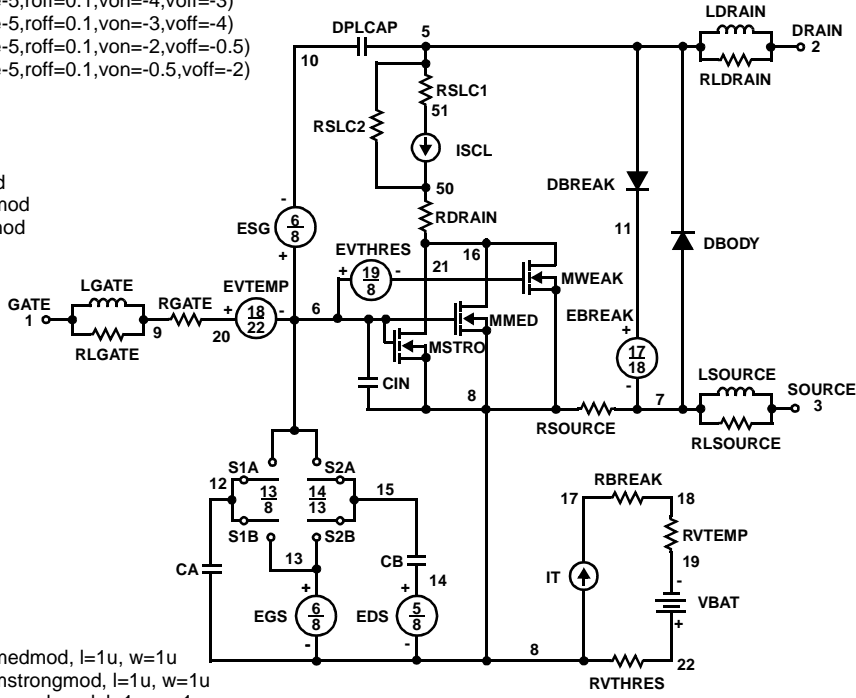

PSPICE Thermal Model

REV 23 May 2004

FDB8874T

```
CTHERM1 TH 6 1.9e-3
CTHERM2 6 5 2.8e-3
CTHERM3 5 4 3.5e-3
CTHERM4 4 3 3.6e-3
CTHERM5 3 2 4.0e-3
CTHERM6 2 TL 1.6e-2
```

```
RTHERM1 TH 6 3.8e-2
RTHERM2 6 5 5.0e-2
RTHERM3 5 4 1.0e-1
RTHERM4 4 3 1.8e-1
RTHERM5 3 2 3.5e-1
RTHERM6 2 TL 3.7e-1
```

SABER Thermal Model

SABER thermal model FDB8874T
 template thermal_model th tl
 thermal_c th, tl

```
{
ctherm.ctherm1 th 6 =1.9e-3
ctherm.ctherm2 6 5 =2.8e-3
ctherm.ctherm3 5 4 =3.5e-3
ctherm.ctherm4 4 3 =3.6e-3
ctherm.ctherm5 3 2 =4.0e-3
ctherm.ctherm6 2 tl =1.6e-2
```

```
rtherm.rtherm1 th 6 =3.8e-2
rtherm.rtherm2 6 5 =5.0e-2
rtherm.rtherm3 5 4 =1.0e-1
rtherm.rtherm4 4 3 =1.8e-1
rtherm.rtherm5 3 2 =3.5e-1
rtherm.rtherm6 2 tl =3.7e-1
}
```

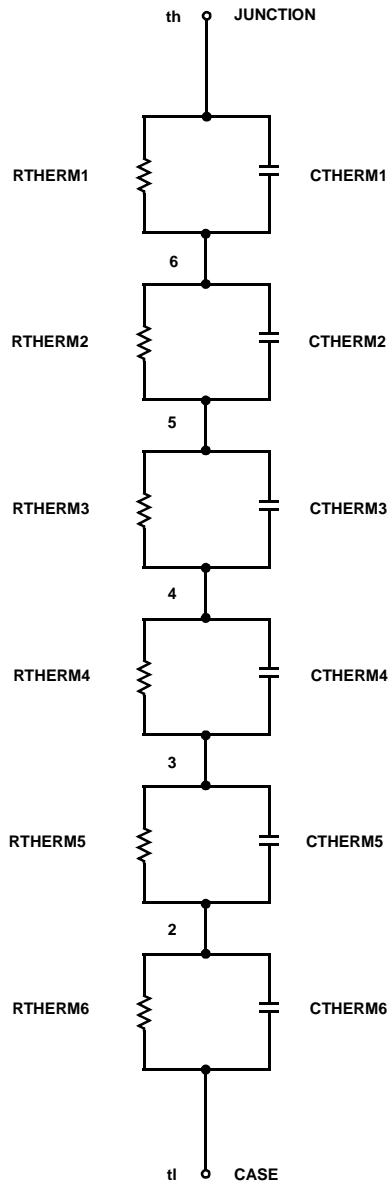



TRADEMARKS

The following includes registered and unregistered trademarks and service marks, owned by Fairchild Semiconductor and/or its global subsidiaries, and is not intended to be an exhaustive list of all such trademarks.

- | | | | |
|---|---|---|---|
| ACEx® | FPS™ | PDP-SPM™ | The Power Franchise® |
| Build it Now™ | F-PFS™ | Power-SPM™ | power the franchise |
| CorePLUS™ | FRFET® | PowerTrench® | TinyBoost™ |
| CorePOWER™ | Global Power ResourceSM | Programmable Active Droop™ | TinyBuck™ |
| CROSSVOLT™ | Green FPS™ | QFET® | TinyLogic® |
| CTL™ | Green FPS™ e-Series™ | QS™ | TINYOPTO™ |
| Current Transfer Logic™ | GTO™ | Quiet Series™ | TinyPower™ |
| EcoSPARK® | IntelliMAX™ | RapidConfigure™ | TinyPWM™ |
| EfficientMax™ | ISOPLANAR™ | Saving our world 1mW at a time™ | TinyWire™ |
| EZSWITCH™ * | MegaBuck™ | SmartMax™ | µSerDes™ |
|  | MICROCOUPLER™ | SMART START™ |  |
|  | MicroFET™ | SPM® | UHC® |
| Fairchild® | MicroPak™ | STEALTH™ | Ultra FRFET™ |
| Fairchild Semiconductor® | MillerDrive™ | SuperFET™ | UniFET™ |
| FACT Quiet Series™ | MotionMax™ | SuperSOT™-3 | VCX™ |
| FACT® | Motion-SPM™ | SuperSOT™-6 | VisualMax™ |
| FAST® | OPTOLOGIC® | SuperSOT™-8 | |
| FastvCore™ | OPTOPLANAR® | SuperMOS™ | |
| FlashWriter® * |  |  | |

* EZSWITCH™ and FlashWriter® are trademarks of System General Corporation, used under license by Fairchild Semiconductor.

DISCLAIMER

FAIRCHILD SEMICONDUCTOR RESERVES THE RIGHT TO MAKE CHANGES WITHOUT FURTHER NOTICE TO ANY PRODUCTS HEREIN TO IMPROVE RELIABILITY, FUNCTION, OR DESIGN. FAIRCHILD DOES NOT ASSUME ANY LIABILITY ARISING OUT OF THE APPLICATION OR USE OF ANY PRODUCT OR CIRCUIT DESCRIBED HEREIN; NEITHER DOES IT CONVEY ANY LICENSE UNDER ITS PATENT RIGHTS, NOR THE RIGHTS OF OTHERS. THESE SPECIFICATIONS DO NOT EXPAND THE TERMS OF FAIRCHILD'S WORLDWIDE TERMS AND CONDITIONS, SPECIFICALLY THE WARRANTY THEREIN, WHICH COVERS THESE PRODUCTS.

LIFE SUPPORT POLICY

FAIRCHILD'S PRODUCTS ARE NOT AUTHORIZED FOR USE AS CRITICAL COMPONENTS IN LIFE SUPPORT DEVICES OR SYSTEMS WITHOUT THE EXPRESS WRITTEN APPROVAL OF FAIRCHILD SEMICONDUCTOR CORPORATION.

As used herein:

- Life support devices or systems are devices or systems which, (a) are intended for surgical implant into the body or (b) support or sustain life, and (c) whose failure to perform when properly used in accordance with instructions for use provided in the labeling, can be reasonably expected to result in a significant injury of the user.
- A critical component in any component of a life support, device, or system whose failure to perform can be reasonably expected to cause the failure of the life support device or system, or to affect its safety or effectiveness.

PRODUCT STATUS DEFINITIONS

Definition of Terms

| Datasheet Identification | Product Status | Definition |
|--------------------------|------------------------|--|
| Advance Information | Formative or In Design | This datasheet contains the design specifications for product development. Specifications may change in any manner without notice. |
| Preliminary | First Production | This datasheet contains preliminary data; supplementary data will be published at a later date. Fairchild Semiconductor reserves the right to make changes at any time without notice to improve design. |
| No Identification Needed | Full Production | This datasheet contains final specifications. Fairchild Semiconductor reserves the right to make changes at any time without notice to improve the design. |
| Obsolete | Not In Production | This datasheet contains specifications on a product that is discontinued by Fairchild Semiconductor. The datasheet is for reference information only. |